

Conveyor Skirt Systems



TSGlobal[®]
Conveyor & Polyurethane Specialists



TSGlobal[®]
Conveyor & Polyurethane Specialists

With more than two decades of experience, TS Global is a proudly Australian-owned company that specialises in producing a diverse array of premium-grade conveyor accessories and polyurethane components. We boast an exceptional team of engineers and manufacturers who possess the skills and expertise to create cutting-edge solutions that can withstand even the most challenging conditions.

TS Global has developed a diverse and market leading range of skirt systems to suit all applications and provide protection to your conveyor system.

-  Proven Performance
-  Quality Product
-  Flexibility in Design
-  On-time Delivery

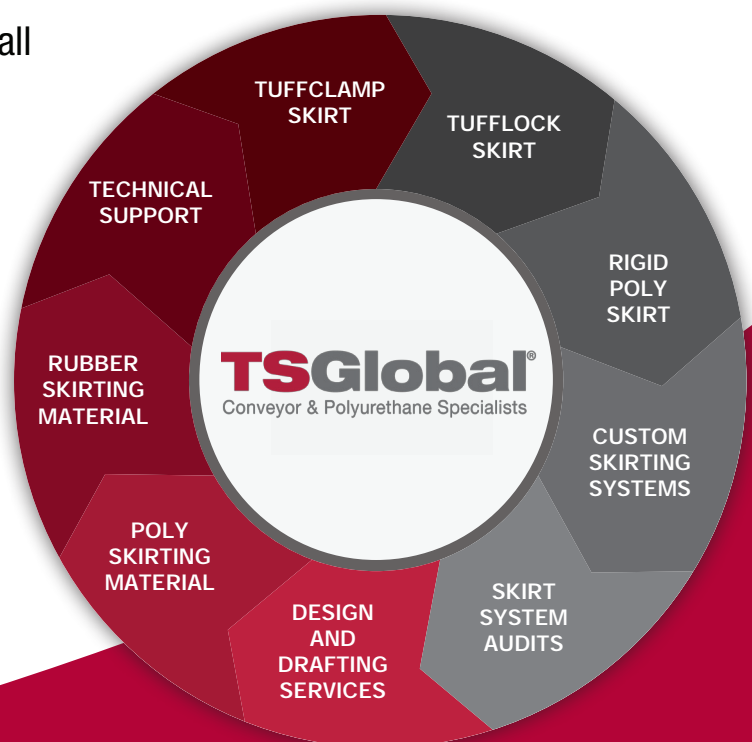

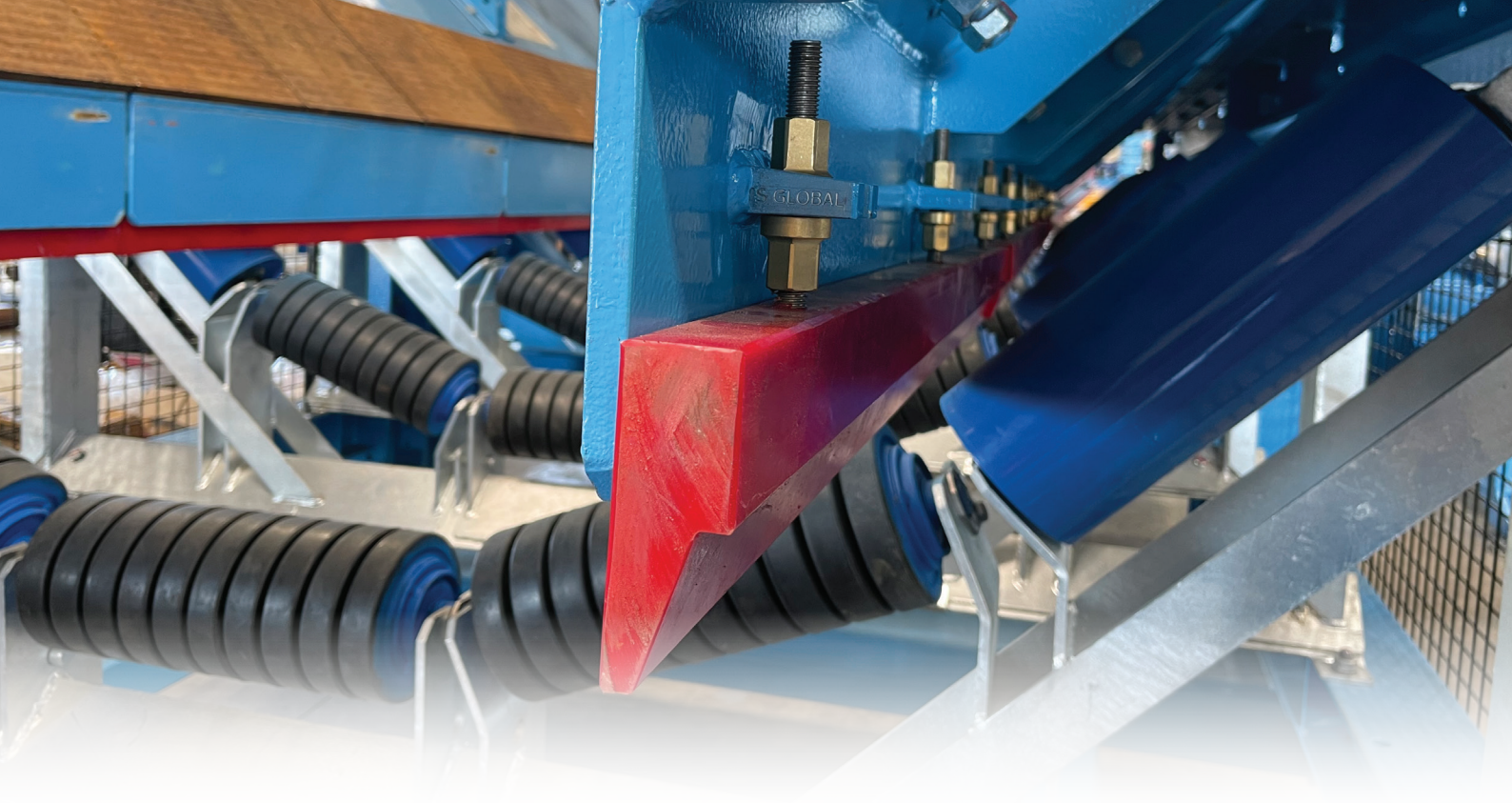

WHY

In mining operations, materials handling constitutes a major component of production costs. Conveyors play a central role in the operations processing, storage and transportation of materials. It is essential that they operate efficiently with maximum availability and with a minimum of down-time.

When operating a conveyor system, product losses due to spillage around a transfer point will occur if not correctly retained. This spillage will impact on the environment, equipment life and increase site hazards and operational costs. By understanding the product being conveyed, we are able to design solutions that will deliver significant improvements to your conveyor performance.

WHERE

It is best practice to install a skirt system complete with a removable wear liner, structural mounting plate and a sealing element on every transfer point along the conveyor. The skirt system needs to be designed to ensure that its length is adequate to retain and settle the product while it is in transition from one conveyor to another.

HOW

An effective skirt system comprises of a steel skirt plate, wear liner and a dust sealing mechanism. The steel skirt plate is designed to mount the wear liner and sealing mechanism. The wear liner is designed to control and direct active product through transition until it settles in the trough of the outgoing conveyor belt. The sealing mechanisms only function is to retain dust within the transfer point.



CUSTOM SKIRTING SYSTEMS

At TS Global, we take pride in delivering solution-based offers for our Skirting Systems. We understand the importance of an effective conveyor skirt system at transfer points to ensure optimal performance and minimise damage to your equipment.

Our skirting system is designed with a focus on reducing the air gap between the soft and hard skirt, which prevents rogue material being trapped between these surfaces, causing premature conveyor belt skirt line damage. The system comprises of three main components: a steel skirt plate (mounting plate), a wear liner (hard skirt), and a dust sealing mechanism (soft skirt).

Mounting Plate: Our steel skirt plate is a versatile mounting plate that allows for easy customisation for each application. This can be manufactured from stainless or mild steel. The purpose of this plate is designed to mount the adjustable hard skirt utilising our unique external adjustment mechanism. We manufacture a range of soft skirt clamping systems that can be utilised.

Hard Skirt: The hard skirt's main purpose is to control and direct the bulk material flow through the loading point. Typically, the hard skirt should be set 3-5mm off the conveyor belt, this is to ensure only fines material presents to the soft skirt. This minimises the risk of skirt failure. We have a range of hard skirting solutions available in Bisalloy, Hardox, Duplplate, or ceramic for heavy duty applications.

Soft Skirt: The soft skirt's main function is to provide an effective seal between itself and the conveyor belt. Allowing the retention of fines material within the skirting system and ultimately reducing dust emissions. We have a range of soft skirting options available in both rubber and polyurethane materials.

At TS Global, we custom design our product for each application, whether for new or existing conveyor systems.

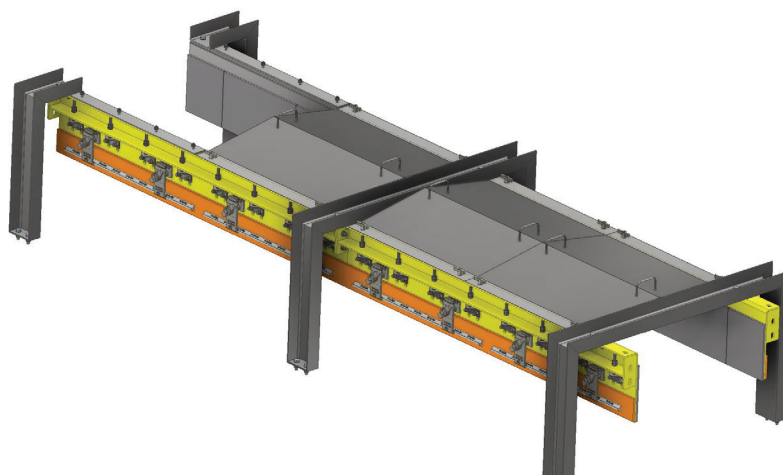

TuffClamp Skirt System



- All transfer points
- Flexible installation
- Easy adjustment/replacement
- Clamp rail positively retained
- Supplied in 1m (40") lengths

TuffLock Skirt System

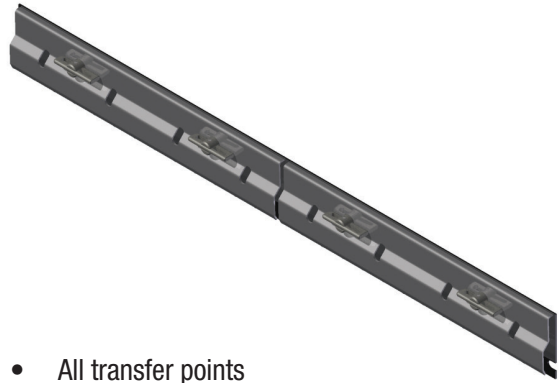

- All transfer points
- Simple adjustment/replacement
- Robust design
- Supplied in 1.2m (48") lengths

Rigid Poly Skirt System

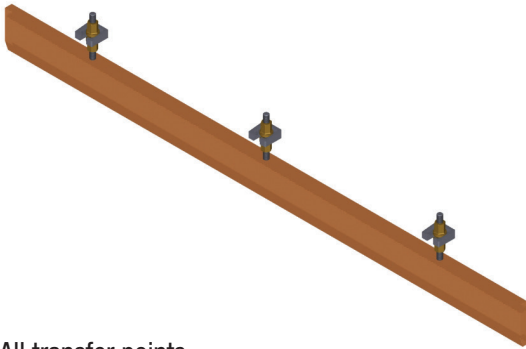

- All transfer points
- Flexible installation
- Easy adjustment/replacement
- High abrasion resistance
- 85 shore A durometer (other durometers available on request)
- Supplied in 1.34m (53") lengths

Rubber Skirt

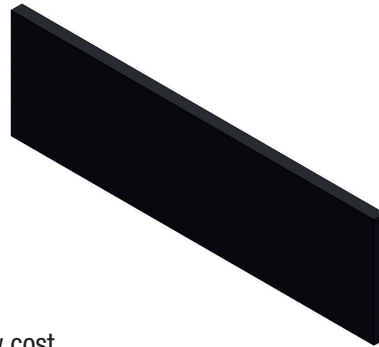

- Low cost
- Available in 30m (100ft) rolls
- 65 durometer standard (other durometers available on request)
- Available in a range of thicknesses and widths

Polyurethane Skirt



- High abrasion resistance
- 63 shore A durometer standard (other durometers available)
- Available in 30m (100ft) rolls
- Available in a range of thicknesses and widths
- Available with 45° bevelled edge
- Available in FRAS

Stock Polyurethane Sizes

Width mm (inches)	Thickness mm (inches)
100mm (4)	12mm (1/2)
150mm (6)	12mm (1/2)
200mm (8)	12mm (1/2)
250mm (10)	12mm (1/2)
75mm (3)	15mm (5/8)
100mm (4)	15mm (5/8)
150mm (6)	15mm (5/8)
200mm (8)	15mm (5/8)
250mm (10)	15mm (5/8)
150mm (6)	19mm (3/4)

*Other sizes available on request.

Installation Guides

TUFFCLAMP SKIRT INSTALLATION GUIDE

Low Profile TuffClamp Skirt System

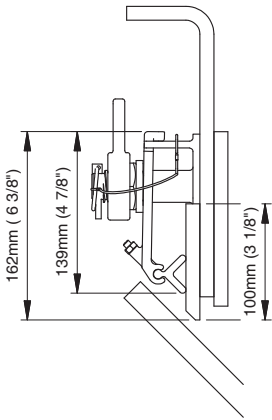

Standard TuffClamp Skirt System

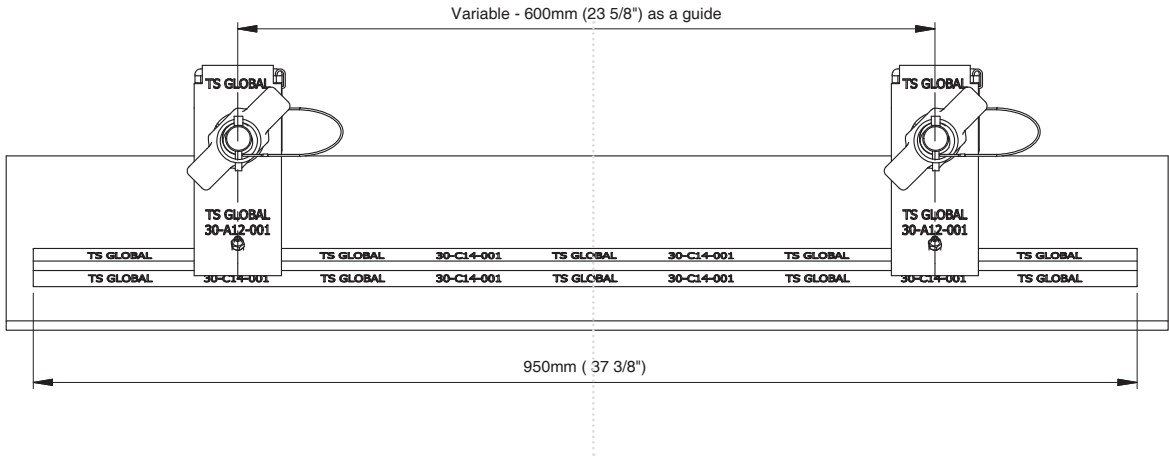
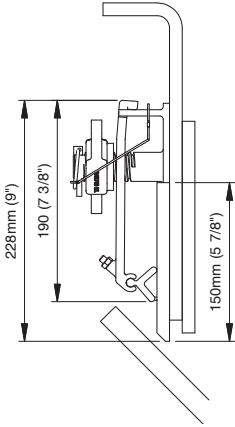

TUFFLOCK SKIRT INSTALLATION GUIDE

Low Profile TuffLock Skirt System	Standard TuffLock Skirt System
-----------------------------------	--------------------------------

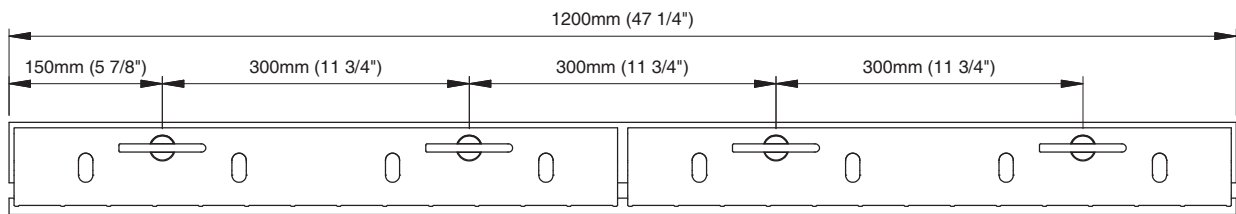
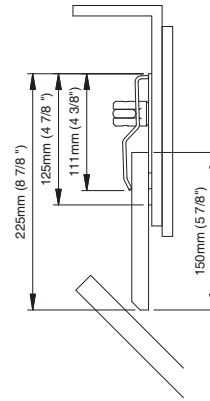
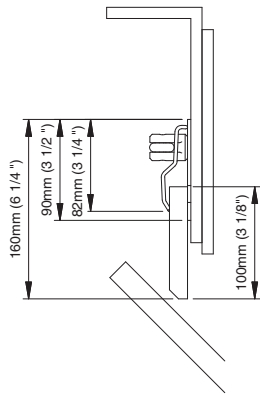

RIGID POLY SKIRT INSTALLATION GUIDE

Standard Rigid Poly Skirt System

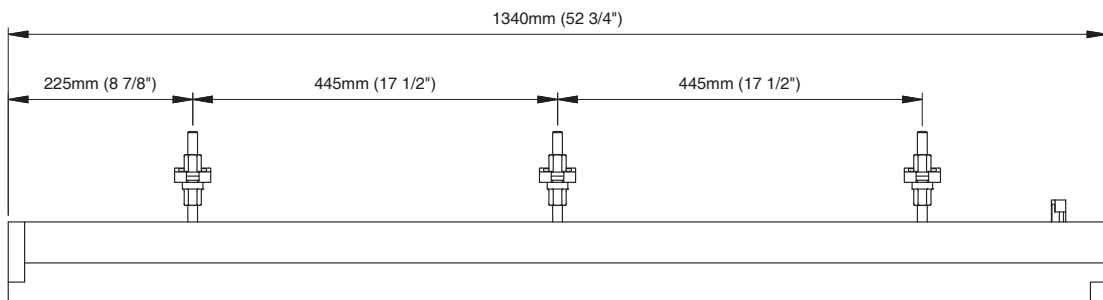
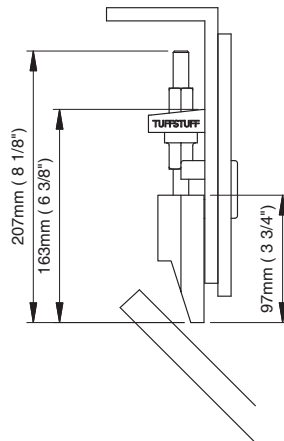



TSGlobal[®]

Conveyor & Polyurethane Specialists



PHONE 1300 418 298 • **EMAIL** sales@tsglobal.net.au • **WEB** www.tsglobal.net.au

WELSHPOOL WA • **TOMAGO NSW** • **MACKAY QLD**

ABN 30 603 644 748

