

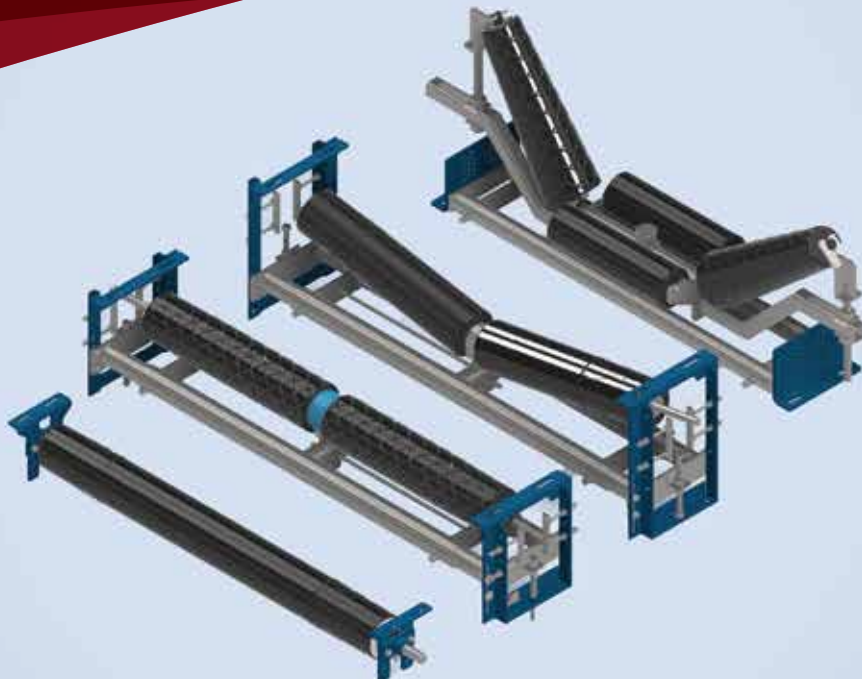

The Future of Belt Tracking





Stop misalignment before it halts operations.

Conveyor belt misalignment is one of the most costly and disruptive problems in bulk materials handling - causing belt and structural damage, material spillage, excess power consumption, and unplanned downtime. Traksure was built specifically to solve it.

An Australian-designed and stocked range of tapered tracking frames and rollers, Traksure delivers immediate, responsive belt correction without the edge damage risks associated with traditional guide roller systems.

Now available exclusively through TS Global, Australia's leading Australian-owned manufacturer of conveyor products, the Traksure range brings together engineered performance and nationwide supply reliability that mining and bulk handling operations depend on.

Why Traksure?

Availability

- ▶ Locally stocked
- ▶ Reduced lead times compared with import alternatives
- ▶ Reliable stock levels
- ▶ TS Global Exclusive Australian partner
- ▶ FRAS Options available for underground operations

Simplified Specification

- ▶ Streamlined product range
- ▶ Clear separation between SD, HD and EXHD
- ▶ All rollers are HD as standard
- ▶ Reduced specification errors
- ▶ Interchangeable rollers

Engineered Performance

- ▶ Reliable performance
- ▶ Precision balanced rollers
- ▶ Upgraded bearings and seals
- ▶ Consistent lagging quality

National Distribution

- ▶ TS Global will hold stock nationally
- ▶ Provide rapid dispatch capability
- ▶ Leverage national sales coverage
- ▶ Offer technical support across all states



PROVEN PERFORMANCE



QUALITY PRODUCTS



FLEXIBILITY IN DESIGN



ON-TIME DELIVERY



AUSTRALIAN OWNED



➤ Simplified Product Range

- ▶ Streamlined range with unnecessary SKUs removed
- ▶ No belt-width crossover between SD, HD, and EXHD
- ▶ All return rollers supplied with both thrust and ball bearings
- ▶ Standardised 16mm return roller lagging (vs common 12mm)
- ▶ Compact return frame base with increased height adjustment
- ▶ Reduced stockholding requirements and fewer specification errors

➤ Upgraded Bearings & Seal Packages

- ▶ Traksure has reset the standard with a superior sealing package and higher bearing specification
- ▶ Enhanced contamination resistance and extended operational life

➤ Roller Balancing & Precision

- ▶ Traksure rollers balance to 25g - 10 times below industry standard
- ▶ Benefits: reduced noise, reduced vibration, improved bearing life
- ▶ Injection-moulded lagging delivers ~0.4mm T.I.R (vs 1–2mm typical)

➤ Lagging Life & Consistency

- ▶ Supplied with wear resistant injection moulded rubber lagging
- ▶ Increased precision and extended lagging life

➤ Full Lagging Options

- ▶ Natural rubber
- ▶ FRAS-certified rubber
- ▶ Polyurethane lagging (natural and FRAS options)

➤ Frame Durability

- ▶ All frames hot dip galvanised (HDG)
- ▶ Lower lifecycle cost
- ▶ Superior corrosion resistance vs powder coat

➤ Trough Frame Adjustment

- ▶ Improved adjustment range: 37°– 55°
- ▶ Broader application and suitability



CORE features built in..

Traksure's tapered tracking rollers are the core of the range. Unlike conventional guide rollers that rely on direct belt contact and react slowly to misalignment, Traksure's tapered design responds immediately when deviation occurs, guiding the belt back to centre before damage can escalate. The technology behind the system has been refined over more than 40 years. Every Traksure roller is built to heavy-duty specification with injection-moulded lagging for exceptional wear resistance. Fire-Resistant Anti-Static variants are available for underground applications, and the full range performs consistently across wet, dry, and bi-directional conveyor systems.

Frames are hot-dip galvanised as standard, providing reliable protection against the highly corrosive and acidic conditions common across Australian mine sites. Traksure's bearing seal systems are engineered to withstand extreme operating environments, including high-pressure washdowns, reducing the risk of contamination and premature bearing failure.

As an Australian-owned business, Traksure is purpose-built for local industry conditions - from the heavy-duty demands of Pilbara iron ore operations to the strict compliance requirements of East Coast underground coal mining. Products are distributed exclusively through TS Global, ensuring strong national coverage and the fast, dependable supply turnaround that maintenance schedules demand.



 BELT WIDTH
450-1500BW



Single Roll Flat Return Tracker

A compact, low-maintenance tracking solution for belt widths from 450mm to 1500mm, the Single Roll Flat Return Tracker is designed for fast installation and instant response. Its heavy-duty cast central pivot activates dynamically the moment misalignment occurs, guiding the belt back to centre without delay.

Sealed-for-life bearings require no regreasing and no scheduled bearing maintenance, making this the lowest-maintenance option in the Traksure range. Individual roller replacement is straightforward when required, keeping any unplanned downtime to a minimum.

Standard 16mm injection-moulded lagging is available in wear-resistant natural rubber, FRAS rubber, and FRAS polyurethane. All Single Roll Flat Return rollers carry a dual deep-groove ball bearing and thrust bearing configuration, suitable from standard through to super-heavy-duty applications. Custom belt widths are available on request.

Performs reliably in all conditions including bi-directional belt operation.

-  **Sealed-for-life bearings**
-  **ZERO regreasing**

-  AUSTRALIAN STOCKED
-  NO GUIDE ROLLERS
-  TRIPLE LABYRINTH SEALED
-  BI-DIRECTIONAL PERFORMANCE
-  CUSTOM SIZES AVAILABLE
-  QUICK CHANGE ROLLERS



Our highly trained site service team have applied Denso tape to provide enhanced protection for the shaft, helping prevent deterioration and extend service life in harsh operating conditions.



INJECTION MOULDED LAGGING
Superior wear resistance and 16mm as standard increasing roller life.

HIGH PERFORMANCE BEARINGS
Superior quality bearings providing smooth long lasting operation. Both ball and thrust bearings used across full range.



INDUSTRY PROVEN SEAL PACKAGE
Three layers of bearing protection preventing ingress of foreign material. The optimal balance between sealing and frictional resistance.



Vee Dual Return Tracker

Flat Dual Return Tracker

The Vee Dual Return Tracker delivers the same heavy-duty tracking performance as the Flat Dual Return while accommodating the natural profile of a troughed belt — no need to flatten the belt at the installation point. Available in a standard 10° angle and compatible with configurations from 5° to 15°, it covers belt widths from 1050mm to 3000mm, with custom sizes available on request.

Built for the demands of wide belt, high-tonnage operations, the Flat Dual Return Tracker delivers reliable belt correction in heavy-duty applications from 1050mm to 3000mm belt width, with custom sizes available on request.

A heavy-duty pivot casting ensures smooth, consistent operation across the full belt width range, while the exterior central bearing pivot provides balanced correction response. The compact frame suits low-clearance installations, and the adjustable base allows precise mounting without complicated setup.

The exterior central bearing pivot provides balanced operation across the full belt width range, while the compact frame profile opens up installation options in low-clearance areas. An adjustable base allows precise mounting location, keeping installation straightforward and safe. Centre pivot bearings are serviceable via an integrated lubrication line, extending service intervals without major disassembly.

As with the full Dual Return range, individual rollers are independently replaceable for fast servicing, and all rollers are supplied with a dual deep-groove ball bearing and thrust bearing configuration suitable from standard through to super-heavy-duty applications. Standard 16mm injection-moulded lagging is available in wear-resistant natural rubber, FRAS rubber, and FRAS polyurethane compoundings.

Individual rollers can be replaced quickly without removing the entire unit, minimising conveyor downtime. Standard 16mm injection-moulded lagging delivers long wear life, with custom compounding options including wear-resistant natural rubber, FRAS rubber, and FRAS polyurethane for underground and chemically aggressive environments. All Dual Return rollers are supplied with a dual deep-groove ball bearing and thrust bearing configuration, covering standard through to super-heavy-duty applications and simplifying stock requirements for maintenance teams.

Performs reliably in all conditions including bi-directional belt operation.

Performs reliably in all conditions including bi-directional belt operation.

- Compatible 5°-15° trough angles**
- No belt flattening required**

- No belt flattening required**
- Regreasable pivot bearings**

- AUSTRALIAN STOCKED
- NO GUIDE ROLLERS
- TRIPLE LABYRINTH SEALED
- BI-DIRECTIONAL PERFORMANCE
- CUSTOM SIZES AVAILABLE
- QUICK CHANGE ROLLERS

- AUSTRALIAN STOCKED
- NO GUIDE ROLLERS
- TRIPLE LABYRINTH SEALED
- BI-DIRECTIONAL PERFORMANCE
- CUSTOM SIZES AVAILABLE
- QUICK CHANGE ROLLERS

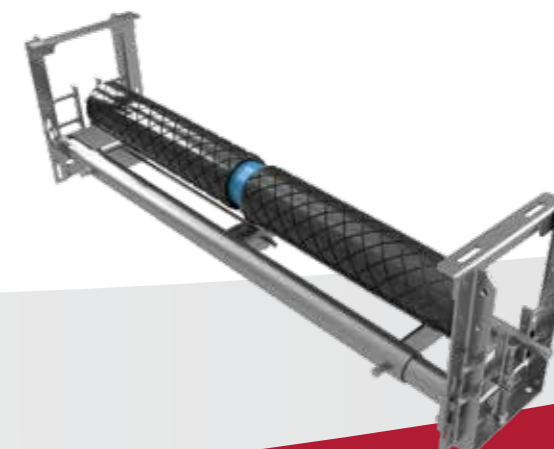

Tapered Trough Trackers

 BELT WIDTH
450-3000BW



Engineered for the carry side of the conveyor, the Tapered Trough Tracker covers the full range of duty specifications and belt widths from 450mm to 3000mm, with custom sizes available on request. The exterior central bearing pivot delivers balanced correction and instant activation regardless of duty level or belt width.

Bearing selection is matched to belt width, with both deep-groove and spherical bearing options available to suit varying load and alignment demands. The compact pivot arm design allows installation within guarded areas without clashing, and the adjustable base enables precise mounting location. An increased trough angle range of 35° to 58° provides greater flexibility across different conveyor configurations.

The non-rotating outer cover cap on the sealing system is specifically designed to eliminate rock jams — a practical advantage in bulk materials environments where debris accumulation around rotating components is a common maintenance issue.

Standard 12mm injection-moulded lagging is available in wear-resistant natural rubber, FRAS rubber, and FRAS polyurethane. Individual rollers are independently replaceable for fast servicing with minimal downtime.

Performs reliably in all conditions including bi-directional belt operation.

-  **Trough angle range 35°-58°**
-  **Rock Jam Resistant Cap Design**



AUSTRALIAN STOCKED



NO GUIDE ROLLERS



TRIPLE LABYRINTH SEALED



BI-DIRECTIONAL PERFORMANCE

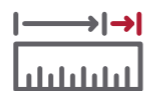

CUSTOM SIZES AVAILABLE



QUICK CHANGE ROLLERS



 Our highly trained site service team delivers complete on-site support for Traksure equipment, from installation and commissioning through to inspection, maintenance and ongoing protection, helping maximise reliability in demanding operating conditions.



INJECTION MOULDED LAGGING

Superior wear resistance and 12mm as standard increasing roller life.

INDUSTRY PROVEN SEAL PACKAGE

Three layers of bearing protection preventing ingress of foreign material. The optimal balance between sealing and frictional resistance.



HIGH PERFORMANCE BEARINGS

Superior quality bearings providing smooth long lasting operation.



TSGlobal®

Conveyor & Polyurethane Specialists



PHONE 1300 418 298 • EMAIL sales@tsglobal.net.au • WEB www.tsglobal.net.au

WELSHPOOL WA • TOMAGO NSW • MACKAY QLD

ABN 30 603 644 748

